

# CLAMPRO®

## weld



## ARC WELDERS

CE

0612

# OPERATING & MAINTENANCE INSTRUCTIONS

Thank you for purchasing this CLARKE Arc Welder.

Before attempting to operate this machine, please read this leaflet thoroughly and follow the instructions carefully, in doing so you will ensure the safety of yourself and that of others around you, and you can look forward to the welder giving you long and satisfactory service.

## GUARANTEE

This CLARKE product is guaranteed against faulty manufacture for a period of 12 months from the date of purchase. Please keep your receipt as proof of purchase.

This guarantee is invalid if the product is found to have been abused or tampered with in any way, or not used for the purpose for which it was intended.

Faulty goods should be returned to their place of purchase, no product can be returned to us without prior permission.

This guarantee does not effect your statutory rights.

## CONTENTS

### PAGE

EMC Regulations .....	3
Safety -General .....	5
Safety -Arc Welding .....	7
Preparation of Working Area .....	10
Additional Safety Precautions for Arc Welders .....	10
Electrical Connections .....	11
Features .....	13
Preparation for Welding .....	13
Assembling the Face Mask .....	15
Welding Technique .....	16
Maintenance .....	18
Thermal Overload .....	18
Duty Cycle/Data Plate Explained .....	20
Electrical Symbols Explained .....	21
Spare Parts & Wiring Diagrams .....	See accompanying booklet

# ELECTROMAGNETIC INTERFERENCE (EMC)

Whilst this unit complies with EMC regulations, the user is responsible for installing and using the welding equipment according to the manufacturers instructions. If electromagnetic disturbances are detected then it shall be the responsibility of the user of the welding equipment to resolve the situation. In some cases this remedial action may be as simple as earthing the welding circuit, see 'Note'. In other cases it could involve constructing an electromagnetic screen enclosing the power source and the work complete with associated input filters. In all cases electromagnetic disturbances must be reduced to the point where they are no longer troublesome.

**Note - The welding circuit may or may not be earthed for safety reasons. Changing the earthing arrangements should only be authorised by a person who is competent to assess whether the changes will increase the risk of injury, e.g. by allowing parallel welding current return paths which may damage the earth circuits of other equipment.**

## 1. ASSESSMENT OF AREA

Before installing welding equipment the user shall make an assessment of potential electromagnetic problems in the surrounding area. Avoid using your inverter in the vicinity of:

- a) other supply cables, control cables, signalling and telephone cables; above, below and adjacent to the welding equipment;
- b) radio and television transmitters and receivers;
- c) computer and other control equipment;
- d) safety critical equipment, e.g. guarding of industrial equipment;
- e) pacemakers and hearing aids etc;
- f) equipment used for calibration or measurement;
- g) other equipment in the environment. The user shall ensure that other equipment being used in the environment is compatible. This may require additional protection measures;

It may be possible to avoid the above by changing the time of day that welding or other activities are to be carried out.

The size of the surrounding area to be considered will depend on the structure of the building and other activities that are taking place. The surrounding area may extend beyond the boundaries of the premises.

## 2. METHODS OF REDUCING EMISSIONS

### 2.1 Mains supply

Welding equipment should be connected to the mains supply according to the manufacturers recommendations. If interference occurs, it may be necessary to

take additional precautions such as filtering of the mains supply. Consideration should be given to shielding the supply cable of permanently installed welding equipment, in metallic conduit or equivalent. Shielding should be electrically continuous throughout its length. The shielding should be connected to the welding power source so that good electrical contact is maintained between the conduit and the welding power source enclosure.

## **2.2 Maintenance of the welding equipment**

The welding equipment should be routinely maintained according to the manufacturers recommendations. All access and service doors and covers should be closed and properly fastened when the welding equipment is in operation. The welding equipment should not be modified in any way except for those changes and adjustments covered in the manufacturers

instructions. In particular, the spark gaps of arc striking and stabilizing devices should be adjusted and maintained according to the manufacturers recommendations.

## **2.3 Welding cables**

The welding cables should be kept as short as possible and should be positioned close together, running at or close to the floor level.

## **2.4 Equipotential bonding**

Bonding of all metallic components in the welding installation and adjacent to it should be considered. However, metallic components bonded to the work piece will increase the risk that the operator could receive a shock by touching these metallic components and the electrodes at the same time. The operator should be insulated from all such bonded metallic components.

## **2.5 Earthing of the workpiece**

Where the workpiece is not bonded to earth for electrical safety, nor connected to earth because of its size and position, e.g. ships hull or building steelwork, a connection bonding the workpiece to earth may reduce emissions in some, but not all instances.

Care should be taken to prevent the earthing of the workpiece increasing the risk of injury to users, or damage to other electrical equipment.

Where necessary, the connection of the workpiece to earth should be made by a direct connection to the workpiece, but in some countries where direct connection is not permitted, the bonding should be achieved by suitable capacitance, selected according to national regulations.

## **2.6 Screening and shielding**

Selective screening and shielding of other cables and equipment in the surrounding area may alleviate problems of interference. Screening of the entire welding installation may be considered for special applications.

# SAFETY PRECAUTIONS

## WARNING:

*As with all machinery, there are certain hazards involved with their operation and use. Exercising respect and caution will considerably lessen the risk of personal injury. However, if normal safety precautions are overlooked, or ignored, personal injury to the operator may result.*

**FAILURE TO FOLLOW THESE RULES MAY RESULT IN SERIOUS PERSONAL INJURY**

## 1. GENERAL PRECAUTIONS

### A) Burn prevention

Wear protective clothing - gauntlet gloves designed for use in welding, hat, and protective shoes. Button shirt collar and pocket flaps, and wear cuffless trousers to avoid entry of sparks and slag. Wear helmet with safety goggles or glasses with side shields underneath, appropriate filter lenses or plates (protected by clear cover glass). This is a MUST for welding or cutting, (and chipping) to protect the eyes from radiant energy and flying metal. Replace cover glass when broken, pitted, or spattered. Avoid oily greasy clothing. A spark may ignite them. Hot metal such as electrode stubs and workpieces should never be handled without gloves. First aid facilities and a qualified first aid person should be available for each shift unless medical facilities are close by for immediate treatment of flash burns of the eyes and skin burns. Ear plugs should be worn when working overhead or in a confined space. A hard hat should be worn when others work overhead. Flammable hair preparations should not be used by persons intending to weld or cut.

### B) Toxic fume prevention

Severe discomfort, illness or death can result from fumes, vapours, heat, or oxygen enrichment or depletion that welding (or cutting) may produce. Prevent them with adequate ventilation. NEVER ventilate with oxygen. Lead-, cadmium-, zinc-, mercury- and beryllium-, bearing materials, when welded (or cut) may produce harmful concentrations of toxic fumes. Adequate local exhaust ventilation must be used, or each person in the area as well as the operator must wear an air-supplied respirator. For beryllium, both must be used. Metals coated with or containing materials that emit toxic fumes should not be heated unless coating is removed from the work surface, the area is well ventilated, or the operator wears an air-supplied respirator. Work in a confined space only while it is being ventilated and, if necessary, while wearing an air-supplied respirator. Vapours from chlorinated solvents can be decomposed by the heat of the arc (or flame) to form PHOSGENE, a highly toxic gas, and other lung and eye irritating products. The ultraviolet (radiant) energy of the arc can also decompose trichloroethylene and perchloroethylene vapours to form phosgene. DO NOT WELD or cut where solvent vapours can be drawn into the welding or cutting atmosphere or where the radiant energy can penetrate to atmospheres containing even minute amounts of trichloroethylene or perchloroethylene.

## C) Fire and explosion prevention

Causes of fire and explosion are:

- 1) combustibles reached by the arc, flame, flying sparks, hot slag or heated material;
- 2) misuse of compressed gases and cylinders;
- 3) short circuits.

BE AWARE THAT flying sparks or falling slag can pass through cracks, along pipes, through windows or doors, and through wall or floor openings, out of sight of the goggled operator. Sparks and slag can fly 10m.

To prevent fires and explosion: keep equipment clean and operable, free of oil, grease, and (in electrical parts) of metallic particles that can cause short circuits. If combustibles are in area, do NOT weld or cut. Move the work if practicable, to an area free of combustibles.

Avoid paint spray rooms, dip tanks, storage areas, ventilators. If the work cannot be moved, move combustibles at least 10m. away out of reach of sparks and heat; or protect against ignition with suitable and snug fitting, fire- resistant covers or shields.

Walls touching combustibles on opposite sides should not be welded on (or cut).

Walls, ceilings, and floor near work should be protected by heat resistant covers or shields. Fire watcher must be standing by with suitable fire extinguishing equipment during and for some time after welding or cutting if:

- a) appreciable combustibles (including building construction) are within 10m.
- b) appreciable combustibles are further than 10m but can be ignited by sparks.
- c) openings (concealed or visible) in floors or walls within 10m can expose combustibles to sparks.
- d) combustibles adjacent to walls, ceilings, roofs or metal partitions can be ignited by radiant or conducted heat.

After work is done, check that area is free of sparks, glowing embers, and flames. An empty container that held combustibles, or that can produce flammable or toxic vapours when heated, must never be welded on or cut, unless container has first been cleaned. This includes.....a thorough steam or caustic cleaning (or a solvent or water washing, depending on the combustible's solubility) followed by purging and inerting with nitrogen or carbon dioxide, and using protective equipment.

Water filling just below working level may substitute for inerting.

A container with unknown contents should be cleaned (see paragraph above), do NOT depend on sense of smell or sight to determine if it is safe to weld or cut. Hollow castings or containers must be vented before welding or cutting - they can explode.

In explosive atmospheres, never weld or cut where the air may contain flammable dust, gas, or liquid vapours.

## 2. ELECTRIC ARC WELDING

Comply with precautions in 1 above, and this section. Arc welding, properly done, is a safe process, but a careless operator invites trouble. The equipment carries high currents at significant voltages. The arc is very bright and hot. Sparks fly, fumes rise, ultraviolet and infrared energy radiates, weldments are hot. The wise operator avoids unnecessary risks and protects himself and others from accidents.

### 2A) BURN PROTECTION

Comply with precautions in 2. The welding arc is intense and visibly bright. Its radiation can damage eyes, penetrate lightweight clothing, reflect from light coloured surfaces, and burn the skin and eyes. Skin burns resemble acute sunburn, those from gas - shielded arcs are more severe and painful.

**DON'T GET BURNED! COMPLY WITH PRECAUTIONS!**

#### 1) Protective clothing

Wear long sleeved clothing (particularly for gas shielded arc) in addition to gloves, hat and shoes (2A). As necessary, use additional protective clothing such as leather jacket or sleeves, flameproof apron, and fire-resistant leggings. Avoid outer garments of untreated cotton. Bare skin protection. Wear dark substantial clothing. Button collar to protect chest and neck and button pockets to prevent entry of sparks.

#### 2) Eye and head protection

Protect eyes from exposure to arc. NEVER look at an electric arc without protection. Welding helmet or shield containing a filter plate shade no. 12 or denser must be used when welding. Place over face before striking arc. Protect filter plate with a clear cover plate. Cracked or broken helmet or shield should NOT be worn; radiation can pass through to cause burns. Cracked, broken, or loose filter plates must be replaced IMMEDIATELY. Replace clear cover plate when broken, pitted, or spattered. WE SUGGEST you wear flash goggles with side shields under the helmet, to give some protection to the eyes should the helmet not be lowered over the face before an arc is struck. Looking at an arc momentarily with unprotected eyes (particularly a high intensity gas-shielded arc) can cause a retinal burn that may leave a permanent dark area in the field of vision. Before welding whilst wearing contact lenses, seek advice from your optician.

#### 3) Protection of nearby personnel

For production welding, a separate room or enclosed bay is best. In open areas, surround the operation with low reflective, non-combustible screens or panels. Allow for free air circulation, particularly at floor level. Provide face shields for all persons who will be looking directly at the weld. Others working in the area should wear flash goggles. Before starting to weld, make sure that screen or bay doors are closed.

## **2B) TOXIC FUME PREVENTION**

Comply with precautions in 2-B. Generator engine exhaust must be vented to the outside air. ***Carbon monoxide can kill.***

## **2C) FIRE AND EXPLOSION PREVENTION**

Comply with precautions in 2-C. Equipment's rated capacity. Do not overload arc welding equipment. It may overheat cables and cause a fire. Loose cable connections may overheat or flash and cause a fire. Never strike an arc on a cylinder or other pressure vessel. It creates a brittle area that can cause a violent rupture or lead to such a rupture later under rough handling.

## **2D) SHOCK PREVENTION**

Exposed live conductors or other bare metal in the welding circuit, or in unearthed, electrically-LIVE equipment can fatally shock a person whose body becomes a conductor. **DO NOT STAND, SIT, LIE, LEAN ON, OR TOUCH** a wet surface when welding, without suitable protection.

## **2E) PROTECTION FOR WEARERS OF ELECTRONIC LIFE SUPPORT DEVICES (PACEMAKERS)**

Magnetic fields from high currents can affect pacemaker operation. Persons wearing electronic life support equipment (pacemaker) should consult with their doctor before going near arc welding, gouging, or spot welding operations.

## **2F) TO PROTECT AGAINST SHOCK:**

Keep body and clothing dry. Never work in damp area without adequate insulation against electrical shock. Stay on a dry duckboard, or rubber mat when dampness or sweat can not be avoided. Sweat, sea water, or moisture between body and an electrically LIVE part - or earthed metal - reduces the body surface electrical resistance, enabling dangerous and possibly lethal currents to flow through the body.

### **1) Earthing the equipment**

When arc welding equipment is earthed according to the National Electrical Code, and the work is earthed, a voltage may exist between the electrode and any conducting object.

Examples of conducting objects include, but are not limited to, buildings, electrical tools, work benches, welding power source cases, workpieces, etc. Never touch the electrode and any metal object unless the welding power source is off. When installing, connect the frames of each unit such as welding power source, control, work table, and water circulator to the building earth.

Conductors must be adequate to carry earth currents safely. Equipment made electrically LIVE by stray current may shock, possibly fatally. Do NOT EARTH to electrical conduit, or to a pipe carrying ANY gas or a flammable liquid such as oil or fuel.



## 2) Electrode holders

Fully insulated electrode holders should be used. Do NOT use holders with protruding screws or with any form of damage.

## 3) Connectors

Fully insulated lock-type connectors should be used to join welding cable.

## 4) Cables

Frequently inspect cables for wear, cracks and damage. IMMEDIATELY REPLACE those with excessively worn or damaged insulation to avoid possibly lethal shock from bared cable. Cables with damaged areas may be taped to give resistance equivalent to original cable. Keep cable dry, free of oil and grease, and protected from hot metal and sparks.

## 5) Terminals and other exposed parts

Terminals and other exposed parts of electrical units should have insulating covers secured before operation.

## 6) Electrode

### a) Equipment with output on/off control (contactor)

Welding power sources for use with the gas metal arc welding, gas tungsten arc welding and similar processes normally are equipped with devices that permit on/off control of the welding power output. When so equipped the electrode wire becomes electrically LIVE when the power source switch is ON and welding gun switch is closed. Never touch the electrode wire or any conducting object in contact with the electrode circuit unless the welding power source is off.

### b) Equipment without output on/off control (no contactor)

Welding power sources used with shielded metal arc welding and similar processes may not be equipped with welding power output on/off control devices. With such equipment the electrode is electrically LIVE when the power switch is turned ON. Never touch the electrode unless the welding power source is off.

## 7) Safety devices

Safety devices such as interlocks and circuit breakers should not be disconnected or shunted out. Before installation, inspection, or service of Equipment, shut OFF all power and remove line fuses (or lock or red-tag switches) to prevent accidental turning ON of power. Do not open power circuit or change polarity while welding. If, in an emergency, it must be disconnected, guard against shock burns, or flash from switch arcing. Always shut OFF and disconnect all power to equipment. Power disconnect switch must be available near the welding power source.

## PREPARATION OF THE WORKING AREA

The working area must be sufficiently spacious, not humid, and well-ventilated as to avoid any fumes which develop from the welding process and from incidental material adhering to the pieces to be welded (oils, paints, tars...) which may cause annoyance to the operator.

Avoid welding by contact with humid parts nearby combustible liquids. Least of all, do not weld upon tanks which may contain inflammable residuals.

## SAFETY EQUIPMENT

A comprehensive range of CLARKE safety equipment for use when welding is available from your local CLARKE dealer.

## ADDITIONAL SAFETY PRECAUTIONS FOR ARC WELDERS

- **NEVER** attempt to remove any of the panels unless the machine is disconnected from the supply.
- **NEVER** use the machine with any of the panels removed.
- **NEVER** attempt any electrical or mechanical repair unless you are a qualified technician. If you have a problem with the machine contact your local CLARKE dealer.
- **NEVER** use or store in a wet/damp environment. **DO NOT EXPOSE TO RAIN.**
- **NEVER** allow children or animals in the vicinity of a welding operation.
- **ALWAYS** remove all flammable materials from the welding area.
- **ALWAYS** ensure that there is full free air circulating around the outer casing of the machine, and that the louvres are unobstructed.
- Welding arc can seriously damage your eyes. Both the operator and any spectators should **ALWAYS** use a proper welding face shield or helmet, with suitable filter lenses. Proper gloves and working clothes should be worn at all times.
- **ALWAYS** wear a pair of safety spectacles/goggles when chipping away slag after welding,. Remember, ordinary eye glasses are not safety glasses.
- **ALWAYS** ensure there is adequate ventilation or extraction in the work area as the welding process gives off toxic fumes.
- **ALWAYS** ensure there is a fire extinguisher on hand.
- **ALWAYS** ensure that a medical supply is on hand, and that treatment for burns is provided.

# ELECTRICAL CONNECTIONS

 **WARNING! THIS APPLIANCE MUST BE EARTHED.**

## A. MODELS FITTED WITH 13AMP PLUG

Welders fitted with a standard 13 amp BS 1363 plug, should be connected to a to a 230 volt (50Hz) domestic electrical supply and **we strongly recommend that this be done via a Residual Current Device (RCD).**

**IMPORTANT: If the welder is fitted with a plug which is moulded onto the electric cable (i.e. non- re-wirable) please note:**

1. The plug must be thrown away if it is cut from the electric cable. There is a danger of electric shock if it is subsequently inserted into a socket outlet.
2. Never use the plug without the fuse cover fitted.
3. Should you wish to replace a detachable fuse carrier, ensure that the correct replacement is used (as indicated by marking or colour code). Replacement fuse covers can be obtained from your local dealer or most electrical stockists.

### Fuse Rating

The fuse in the plug must be replaced with one of the same rating (**13 amps**) and this replacement must be ASTA approved to BS1362.

## B. ALL OTHER MODELS

### 230V Supply

Connect the mains lead to a suitably fused 230 Volt (50Hz) electrical supply. The fuse rating should correspond to that shown on the data plate on the rear panel of the machine. For a full explanation of the data plate, please see page 22 & 23.

**The wires in the mains lead are coloured in accordance with the following code:**

**Green & Yellow ..... Earth**  
**Blue ..... Neutral**  
**Brown ..... Live**

As the colours of the flexible cord of this appliance may not correspond with the coloured markings identifying terminals in your plug, proceed as follows:

- Connect GREEN & YELLOW cord to plug terminal marked with a letter "E" or Earth symbol , or coloured GREEN or GREEN & YELLOW.
- Connect BROWN cord to plug terminal marked letter "L" or coloured RED.
- Connect BLUE cord to plug terminal marked letter "N" or coloured BLACK.

## Dual Supply

For machines capable of operating on 110/230V and 230/400V, the voltage selector is designed so that it can select only one voltage. In order to change voltages on earlier models, it is necessary to change the switch gate as follows:

1. With the voltage selector knob in the OFF position, slacken the knobs' grub screw and remove the knob, to reveal a circular plate.
2. Remove the two screws securing the plate, then reverse the plate.
3. Replace the two plate securing screws followed by the selector knob.

This knob can now be moved to either the 230 or 110/400V position, depending upon the position of the plate.

On later models the position of the screw, arrowed in the illustration opposite will determine the voltage selection.

With the screw in position 1, the switch may be turned from O - OFF to 230V.

With the screw in position 2, the switch may be turned from O - OFF to 400V.



### 110V Supply

A suitably approved 110V connector is required and should be connected to a suitably protected circuit in accordance with the instructions below.

#### **IMPORTANT:**

1. **On no account must a 230V, 13amp (BS1 363) plug be fitted to these machines.**
2. **If a 110V transformer is used, ensure it has a rated capacity sufficient to take the load of this machine...check the data plate.**

### 400V Supply

For wiring to a 400V supply, the colour codes of the wires are as follows:

**Green and Yellow ..... Earth**

**Blue ..... Live (L1)**

**Brown ..... Live (L2)**

## **DANGER - ELECTRIC SHOCK CAN BE FATAL.**

A person qualified in first aid should always be present in the working area. If person is unconscious and electric shock is suspected, do not touch the person if he or she is in contact with the welder or cables. Disconnect the welder from the power source and then use First Aid.

## FEATURES

The welding capabilities of your welder are given on the data label printed on the rear panel of the machine (see list on page 22 for an explanation of markings and symbols).

### Thermal Overload Protection

If the duty cycle of the welder is exceeded (see Specifications), the **Overload Protection Device** will automatically cut the power to prevent damage to the machine. Should the cut-out operate, the amber light on the front panel will illuminate, and you will have to wait until the transformer cools down (approx. 30 minutes), when the overload device will automatically reset itself and you can continue welding. (On smaller welders the lamp is built in to the ON/OFF switch).

Although no harm will be done to the machine if/when the overload device is actuated, its frequent use could eventually result in damage.

## PREPARATION FOR WELDING

1. With the machine correctly connected to the mains supply in accordance with the instructions given under 'Electrical Connections', attach the leads to the machine as shown in Fig.1 on page 14.

Ensure the EARTH lead is connected to the WORKPIECE, and the other lead to the ELECTRODE HOLDER.

**IMPORTANT: Ensure also that the earth clamp is attached to clean, solid metal. If necessary thoroughly clean with a wire brush or similar to guarantee a good connection.**

2. Select the appropriate electrode, which should be approximately the same thickness as the piece to be welded, for single pass welding.
3. Select the appropriate welding current by turning the handwheel (H) and observing the setting on the scale (J), on top of the machine.

**NOTE: With practice you will get a feel for the best current settings for different welding rod thicknesses.**

The chart below is an indicator of the thickness of material/ welding rod thickness and the corresponding welding current. This is intended as a guide only.

SIZE OF WELDING ROD THICKNESS OF METAL	AMPERAGE SETTING
1/16 16 swg      1.5 mm	40-55
14 swg      2.0 mm	50-70
12 swg      2.5 mm	75-95
1/8 10 swg      3.25mm	100-140
4.0 mm	140-180
5.0 mm	100-240
6.0 mm	240-250

This is an illustration of a typical layout. Although with some models, the major components may differ slightly in design and location.

**Fig. 1**

- |   |                            |
|---|----------------------------|
| A | Work Return Lead (Earth)   |
| B | Work Clamp (Earth)         |
| C | Workpiece                  |
| D | Electrode                  |
| E | Electrode Holder           |
| F | Welding Lead               |
| G | Work Terminal              |
| H | Handwheel                  |
| I | Electrode Terminal         |
| J | Thermal Current Indicator  |
| K | Thermal Overload Indicator |
| L | Input Voltage Selector     |

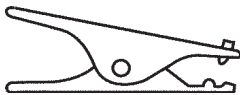
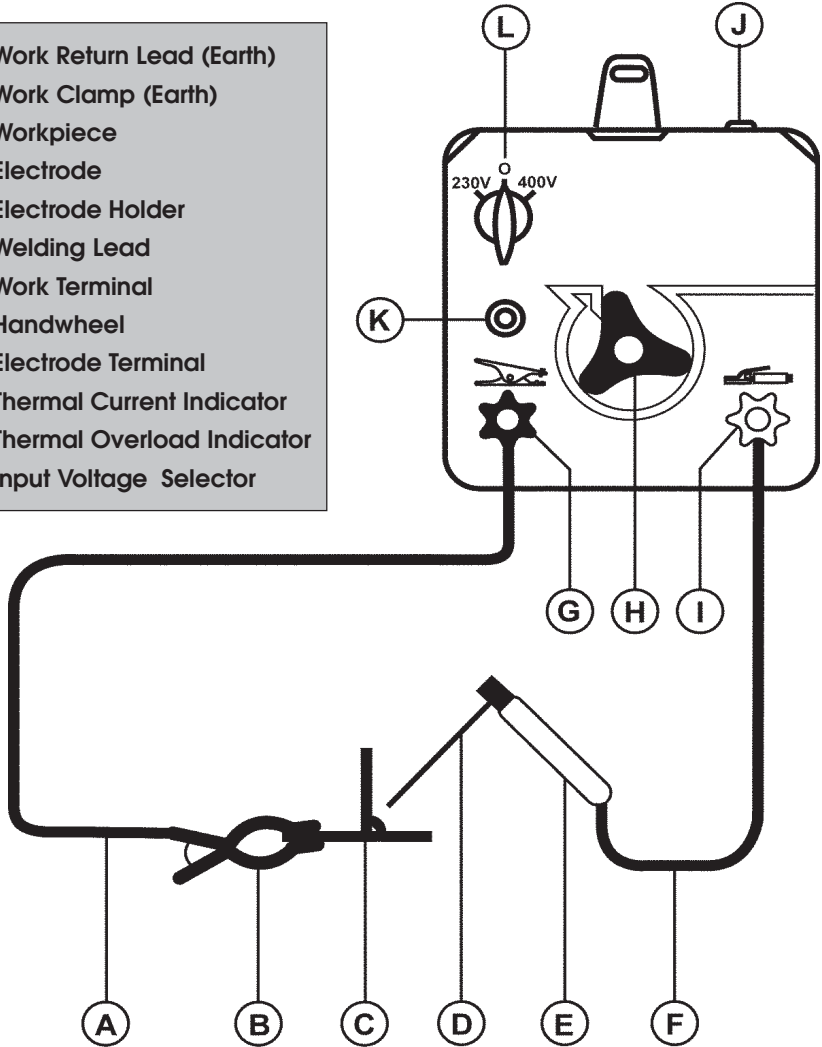

**Work Clamp Symbol (Earth)**

- Identifies work terminal  
(Black Knob)

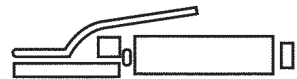

**Electrode Holder Symbol**

- Identifies electrode terminal  
(Red Knob)

## ASSEMBLING THE FACE SHIELD

1. Push the two halves of the shield together as shown.
2. Place the handle into position and secure using the plastic screw and clip provided
3. Working from the inside of the shield, insert the clear glass panel into the recess in the shield, followed by the dark glass panel.
4. Secure the glass panels with the lens surround and plastic screws/clips provided. The clear glass MUST be on the outside of the shield.
5. Finally use the last plastic screw and clip as shown to fix the two halves of the shield together.

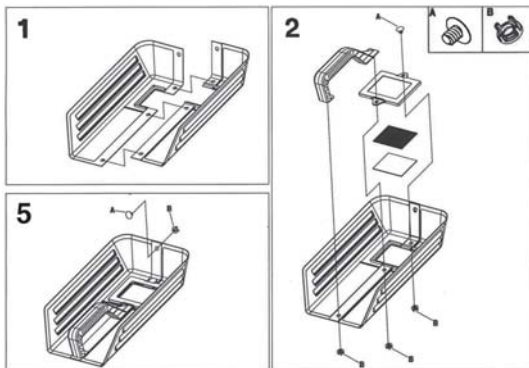

It is important to pay attention to the notes on welding shield maintenance, given on page 18. When replacing the glass panels, use ONLY those parts supplied by Clarke International. The dark panel is a certified, specific optical class, and should not be exchanged for any other type.

The clear glass panel should be replaced when it becomes badly pitted.

### WARNING:

NEVER look at an electric arc without eye protection as this can injure the eyes permanently. ALWAYS use a protection mask or welding helmet.

\_\_\_\_\_ **All components are now correctly assembled, and the welder** \_\_\_\_\_  
**may now be prepared for operation, as detailed in the**  
**following pages**

## WELDING TECHNIQUE

1. With the welder correctly connected to the mains supply and the leads attached to the machine, ensure the earth clamp is firmly attached to the workpiece on CLEAN, SOLID metal, and as close to the proposed weld as is practical, and the appropriate current setting for the job has been set.
2. Switch ON the machine.

### **NOTE:**

***If the machine stops at any time and the amber light on the front panel illuminates, the thermal cutout has intervened. Wait until the transformer has cooled sufficiently for work to recommence. This could take considerable time and is denoted by the amber light going OUT. On smaller machines the lamp is built in to the ON/OFF switch.***

3. Bring the electrode to the work surface at an angle of approx. 70° then, **BEFORE** you strike an arc, bring the face shield up to protect your eyes. Strike an arc by briefly touching the work surface with the tip of the electrode. Once the arc is struck or primed, raise the electrode slightly and maintain it at a distance of approx 1.5mm (1/16") from the work surface, then proceed to move the electrode along its intended path, keeping the tip in the molten pool at all times. An even crackling noise should be heard, which is an indication of a good weld.

### **NOTE:**

***This is the most difficult aspect for most beginners. It is recommended that you practice on some scrap material in order to get a feel of the operation.***

***If the electrode is not withdrawn quickly enough once the arc is primed, there is a possibility that the electrode will weld itself to the workpiece. Should this happen, give it a sharp tug to free it, and try again. If this fails to free it, turn OFF the machine immediately as it will quickly overheat.***

***If you withdraw the electrode too far once the arc is primed, you will lose the arc and have to try again.***

4. Inspect the job carefully. With a correct combination of electrode size and current setting the area of weld should be complete fusion of the electrode and parent metal/s. Any slag which forms on the surface should be chipped away with the pick/brush supplied.

If the resultant weld looks messy and irregular, this is an indication of porosity or slag contamination, and you have almost certainly failed to achieve the correct combination. This is a common problem, so do not worry as practice will quickly cure this.

The following tips should help you improve your welding technique fairly quickly.

### **WARNING**

**When welding ALWAYS ensure there is adequate ventilation in the work area as the welding process give off toxic fumes**



# WELDING PITFALLS

The arc welding technique is an acquired skill and requires considerable practice before perfect results are obtained. The diagrams below will help to explain the pitfalls in your technique and how to overcome them.

## 1. Arc too short

This causes irregular masses of weld to be deposited, with slag contamination on an uneven surface.



## 2. Arc too long

This causes poor penetration resulting in a weak weld with excessive spatter and porosity. Surface of the weld is rough and the arc makes a hissing sound



## 3. Electrode moved too slowly

This causes a very wide and heavy deposit which overlaps at the sides. It is wasteful both in terms of time and electrode use.



## 4. Electrode moved too quickly

This causes poor penetration with a 'stringy' and incomplete weld deposit. Slag is very hard to remove.



## 5. Current too low

This causes poor penetration and causes the electrode to stick to the workpiece too readily. Also results in a very irregular and high weld deposit. Slag is very hard to remove.



## 6. Current too high

This causes excessive penetration with spatter and deep pointed crater. It may also cause holes to be burned in the workpiece.

Burns electrodes very quickly.



## 7. The perfect weld

With the correct combination of arc length, current regulation, inclination and speed of the electrode, you will, with practice produce the perfect weld.

This should be regular with uniform ripples and no slag contamination.

The arc will make a steady, even crackling sound.



## MAINTENANCE

Your Clarke arc welder is a simple and robust unit, requiring virtually no maintenance other than the guidelines shown below.

1. Keep the louvre passages clean to avoid a build up of dirt and oxides inside the machine, which can reduce machine output.
2. Check all cables periodically; they must be in good condition and not cracked.
3. Always try to avoid getting particles of metal inside the machine since they could cause short circuits.
4. Periodically clean the inside of the welder with compressed air, ensuring you wear a mask during the operation.

**IMPORTANT - ALWAYS disconnect from the electrical supply before servicing or cleaning.**

## THE WELDING SHIELD

Always maintain the welding mask in good condition. If the clear glass protection lens becomes badly pitted, sufficient to interfere with vision, or cracked, have it replaced immediately. Replacement clear and dark lenses are available from your Clarke dealer - see Parts Lists for details. NEVER use any dark filter lens other than that provided by CLARKE International, or one with the same certified 'Optical class' (degree of protection).

The shield should always be cleaned with a clean soft cloth after use, ensuring the lenses are clean. Remove any dust that may have accumulated and store it in a safe place where it cannot be damaged. NEVER use a shield that is **not** in perfect condition.

## THERMAL OVERLOAD

If the duty cycle of the welder is exceeded, a thermostat will automatically cut power to the unit to prevent damage. You must wait until the transformer cools sufficiently for the thermostat to reset, at which time you may resume welding. This could take approximately 30 minutes.

Please note that if the overload operates too frequently, damage to the machine will inevitably result.

When the thermal overload has intervened, the amber light on front of the machine will illuminate.

# TYPES OF JOINTS



BUTT JOINT



SINGLE V-JOINT



DOUBLE V-JOINT



SINGLE BEVEL JOINT

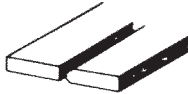

DOUBLE BEVEL JOINT



CORNER JOINT

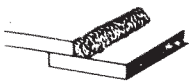

SINGLE FILLET LAP JOINT



DOUBLE FILLET LAP JOINT



SINGLE STRAP JOINT

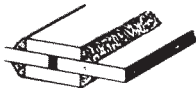

DOUBLE STRAP JOINT



SINGLE FILLET T-JOINT



DOUBLE FILLET T-JOINT

2 to 3 mm.

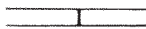

CLOSED JOINT



OPEN JOINT



VEE JOINT

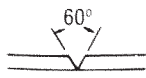

FEATHER EDGE  
3 mm. OR MORE

2 to 3 mm.

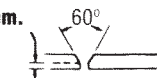

SHOULDER EDGE  
6 mm. OR MORE

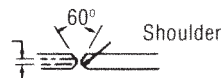

DOUBLE VEE JOINT

Shoulder

# DUTY CYCLES

## Example 1. 235TEN Data Plate

Models up to and including 230TE are covered by Reg's EN 50060 and EN 50199, where the Duty Cycle is expressed as a number of electrodes that may be burned continuously in a given time.







Referring to the table opposite,  $n_c$  indicates the number of electrodes that may be burned before the thermal cutout will operate at a specified welding current.

i.e. using the example above:

..... using 2.5mm dia rods, 34 may be burned continuously at 80 A welding current  
 or ..... using 4.0mm dia rods, 8.5 may be burned continuously at a 160A welding current



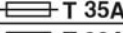



$n_h$  ..... indicates the max. no. of electrodes that may be burned once the overload has operated but has cooled sufficiently for it to begin operating again..the machine is said to be in a 'hot state'.

E/h indicates the max. no. of electrodes of a given size that may be burned per hour

1 ~  1 ~		EN 50060 EN 50199			
	Uo 44 ÷ 48V	50/Hz	I <sub>2</sub> 40 - 210A		
	∅mm	1.6	2	2.5	3.25 4
	I <sub>2</sub> A	40	55	80	115 160
	n <sub>c</sub>	96	69	34	12 8.5
	n <sub>h</sub>	—	—	11	5 3
	U <sub>1</sub> 230V	 T 35A		I <sub>1</sub> MAX 35A	
	U <sub>1</sub> 400V	 T 20A		I <sub>1</sub> MAX 21A	
50/60Hz		IP21		H	

## Example 2. 260TE Data Plate

Models 260TE onwards are covered by regulations EN 60974-1 and EN 50199, where the Duty Cycle (X) is expressed as a percentage of time the machine may be used in a given period for a specified welding current.

<b>Clarke</b> INTERNATIONAL		<b>Clarke</b> weld			
TYPE	<b>260TE</b>		SERIAL NUMBER		
1 ~  1 ~		EN 60974-1 EN50199			
	50A / 22V - 240A / 29.6V				
	1 ~	X	35%	60%	100%
	Uo V	I <sub>2</sub>	211A	160A	125A
	46 ÷ 50V	U <sub>2</sub>	28.5V	26.4V	25V
	U <sub>1</sub> V	 T 50 A	I <sub>1</sub> 48 A	I <sub>1</sub> 36 A	I <sub>1</sub> 31 A
	230V	 T 25 A	I <sub>1</sub> 27 A	I <sub>1</sub> 21 A	I <sub>1</sub> 15 A
COOLING AF	400V				
I.C.L.	H				
IP 21	50/60Hz	S <sub>1</sub>	11kVA	8.4kVA	7kVA

i.e. using the example above:

When welding at 160 Amps the machine may be used for 6 minutes (60%) in any 10 minute period, or, the machine may be used continuously, (100%) when welding at 125 Amps



# NOTES

# NOTES

